

Data Sheet



Article number: 23020346119

Description: E+G Fingergreb MBT.70-B-M12-C9, black centre cap

Measures

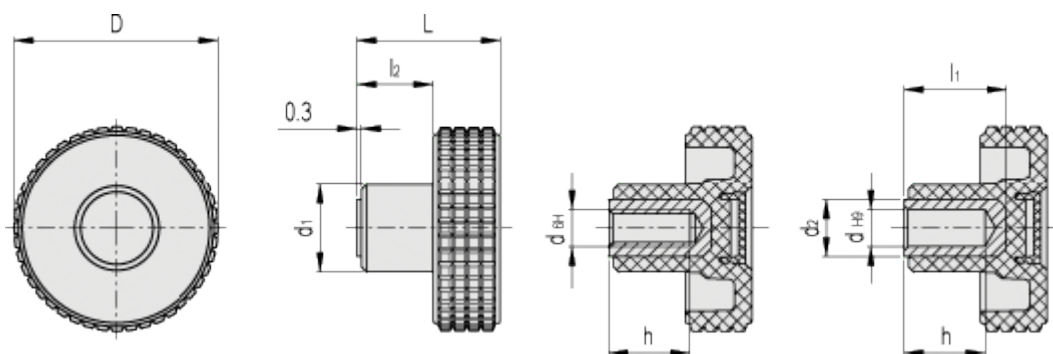

D = 70

d1 = 24

d2 = -

dH6 = M12

dH9 = -

h = 20

L = 42

l1 = -

l2 = 20.5